

INSTALLATION INFORMATION

2 - 2.5T DOGBONE STYLE LIFTING ANCHORS

BOLT CIRCLE - 15" (380MM)

CONDUIT - AS REQUIRED

WEIGHT: 1836 LBS / 833 KG

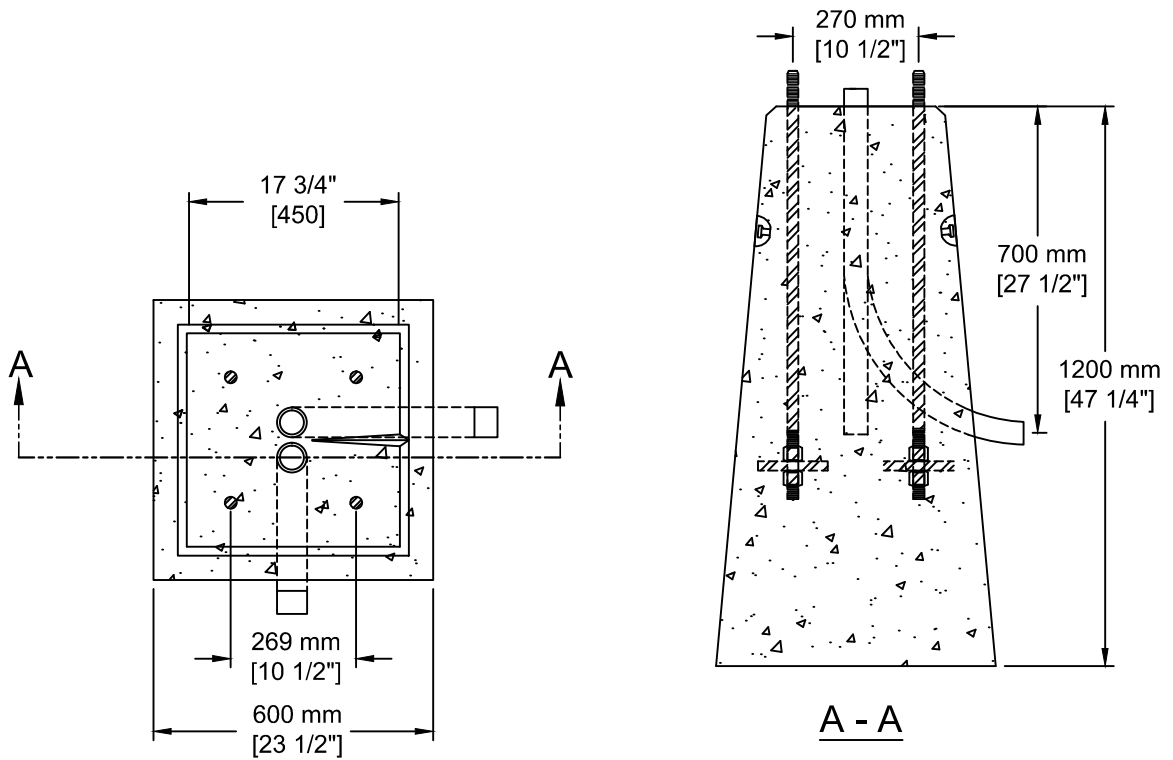

TEL: 250-495-7556
 socp@socp.ca
 www.socp.ca

**MMCD - Type C-3
 Concrete Base**

**Product #
 0973**