

**INSTALLATION INFORMATION**

2 - 2.5T DOGBONE STYLE LIFTING ANCHORS

WEIGHT: 1783 LBS / 809 KG

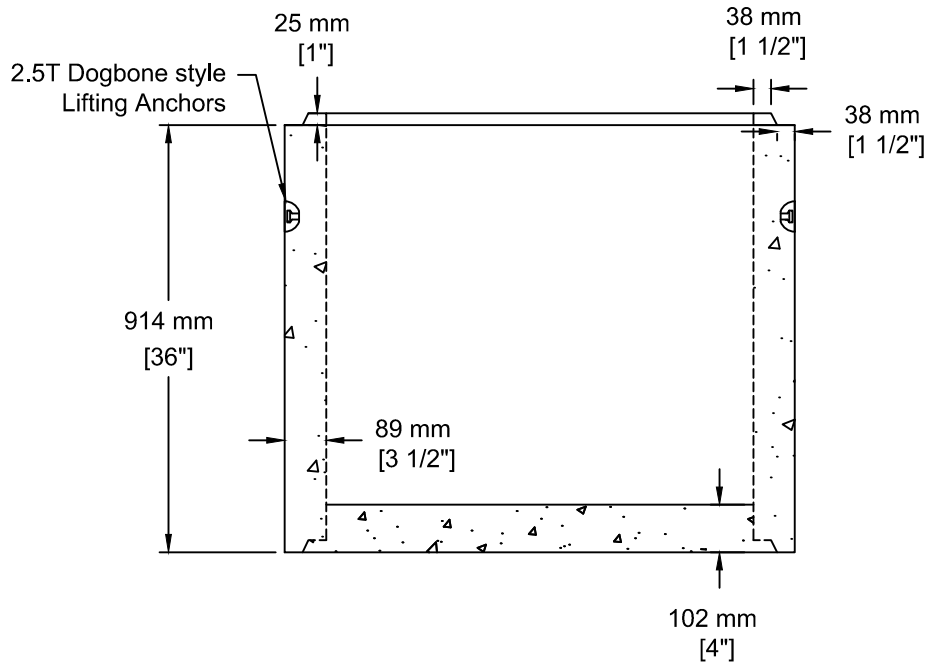

TEL: 250-495-7556  
 socp@socp.ca  
 www.socp.ca

Box 419, 11602 - 115 st Osoyoos, BC V0H 1V0

FAX: 250-495-3556

900 ID (36") x 0.91vm  
 Catch Basin - IB c/w Inside Base

Product #

**0473-IB**