

**INSTALLATION INFORMATION**

2 - 2.5T DOGBONE STYLE LIFTING ANCHORS

WEIGHT: 350 LBS / 159 KG

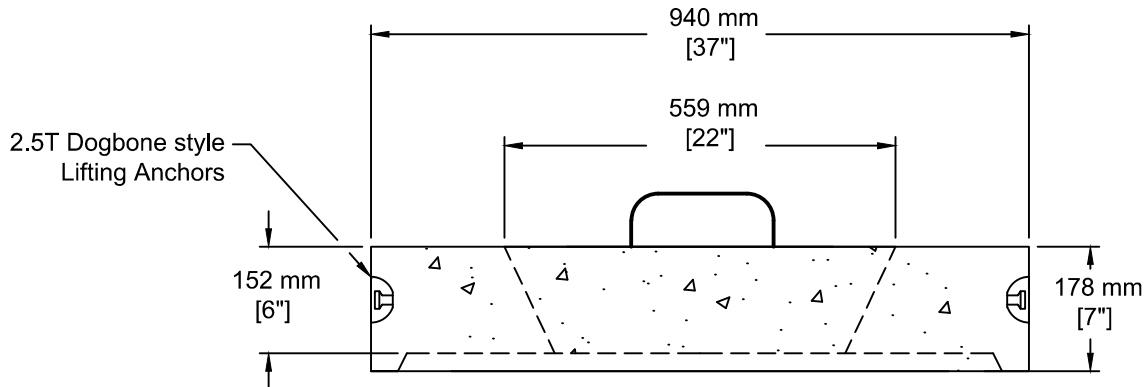

TEL: 250-495-7556  
 socp@socp.ca  
 www.socp.ca

Box 419, 11602 - 115 st Osoyoos, BC V0H 1V0

FAX: 250-495-3556

**750 ID (30") Catch Basin Lid -  
 MHP c/w Manhole Plug**

Product #

**0468**