

**INSTALLATION INFORMATION**

3 - 2.5T DOGBONE STYLE LIFTING ANCHORS

WEIGHT: 1632 LBS / 740 KG

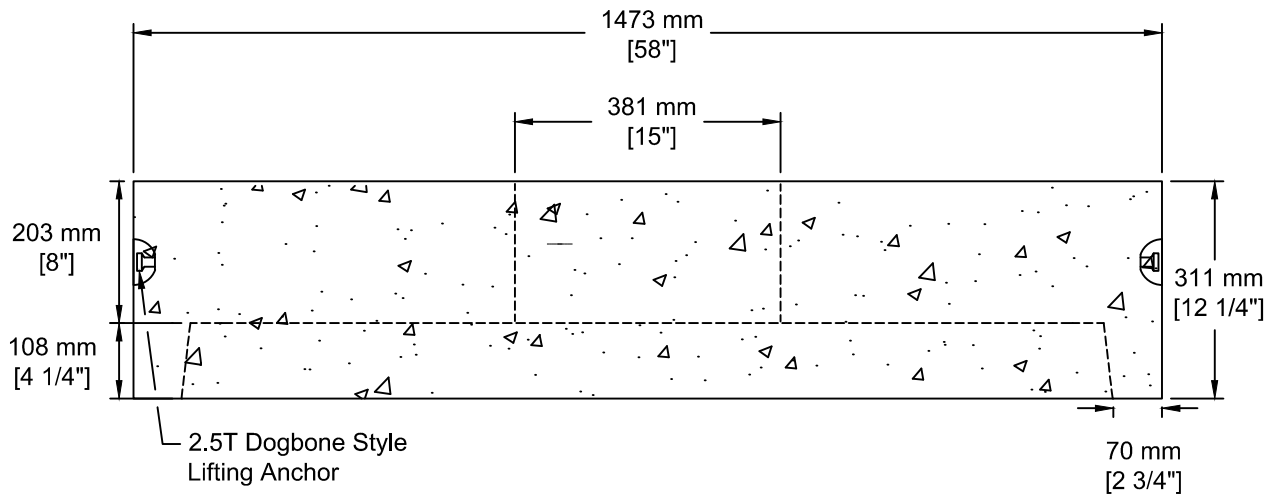

TEL: 250-495-7556  
 socp@socp.ca  
 www.socp.ca

1200 ID (48") Manhole Lid  
 - B37 Op

Product #  
 0347-B37