

INSTALLATION INFORMATION

3 - 2.5T DOGBONE STYLE LIFTING ANCHORS

WEIGHT: 1468 LBS / 666 KG

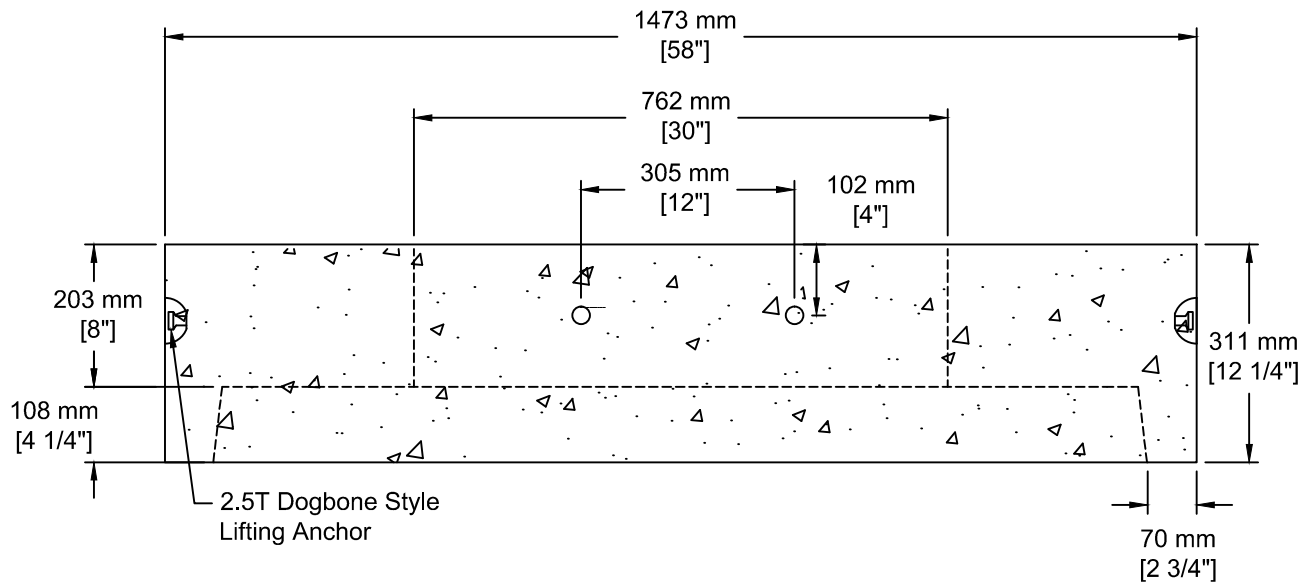

TEL: 250-495-7556
socp@socp.ca
www.socp.ca

1200 ID (48") Manhole Lid
- 762 mm Op

Product #

0347