

**INSTALLATION INFORMATION**  
**DESIGN SPECIFICATION - ASTM C478**  
**2 - 2.5T DOGBONE STYLE LIFTING ANCHORS**  
**WEIGHT: 3825 LBS / 1735 KG**

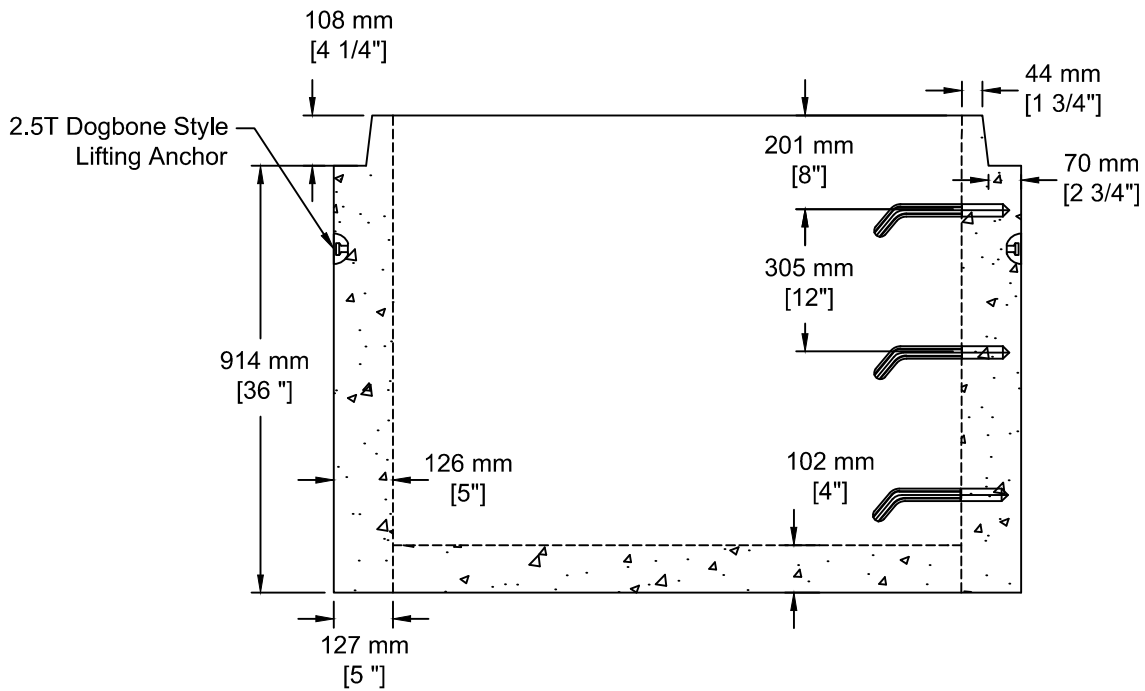

TEL: 250-495-7556  
 socp@socp.ca  
 www.socp.ca

Box 419, 11602 - 115 st Osoyoos, BC V0H 1V0

FAX: 250-495-3556

**1200 ID (48") x 0.91vm**  
**Manhole - IB c/w Inside Base**

**Product #**

**0343-IB**