

INSTALLATION INFORMATION

3 - 2.5T DOGBONE STYLE LIFTING ANCHORS

WEIGHT: 1217 LBS / 553 KG

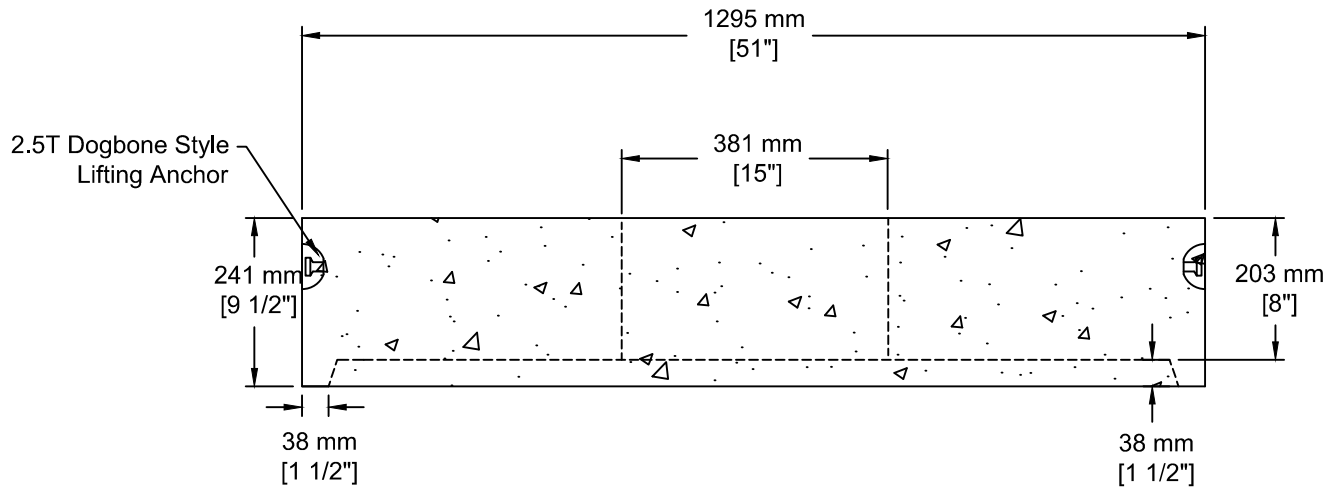

TEL: 250-495-7556
 socp@socp.ca
 www.socp.ca

1050 ID (42") Manhole Lid
 - B37 Op

Product #
 0328-B37