

INSTALLATION INFORMATION
DESIGN SPECIFICATION - ASTM C478
2 - 2.5T DOGBONE STYLE LIFTING ANCHORS
WEIGHT: 1680 LBS / 762 KG

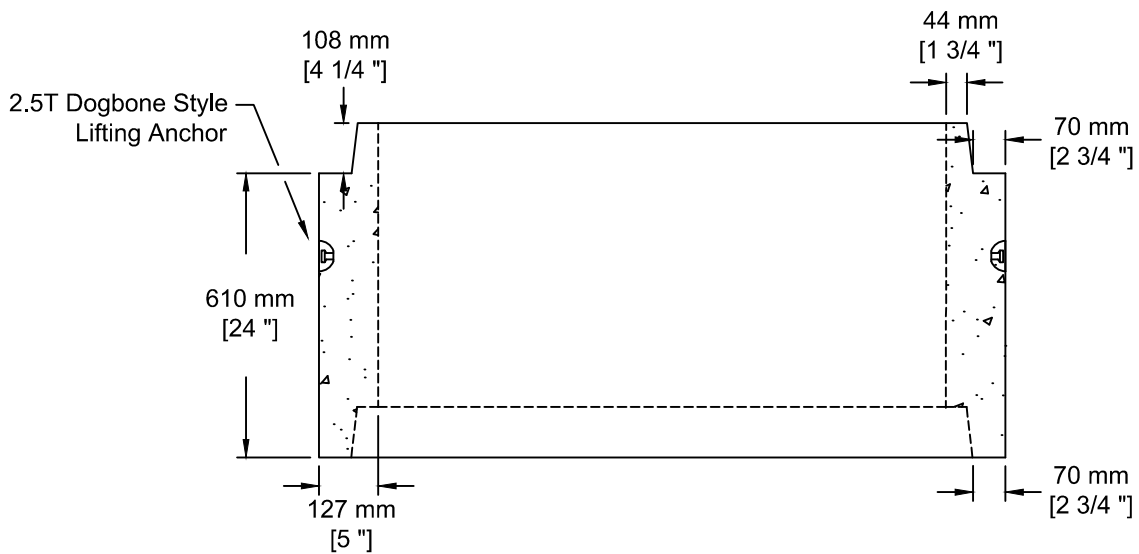

TEL: 250-495-7556
 socp@socp.ca
 www.socp.ca

1200 ID (48") x 0.61vm
 Drywell Solid Riser

Product #

0262