

INSTALLATION INFORMATION

2 - 2.5T DOGBONE STYLE LIFTING ANCHORS (BARREL)

3 - 2.5T DOGBONE STYLE LIFTING ANCHORS (LID)

WEIGHT: 4974 LBS / 2256 KG

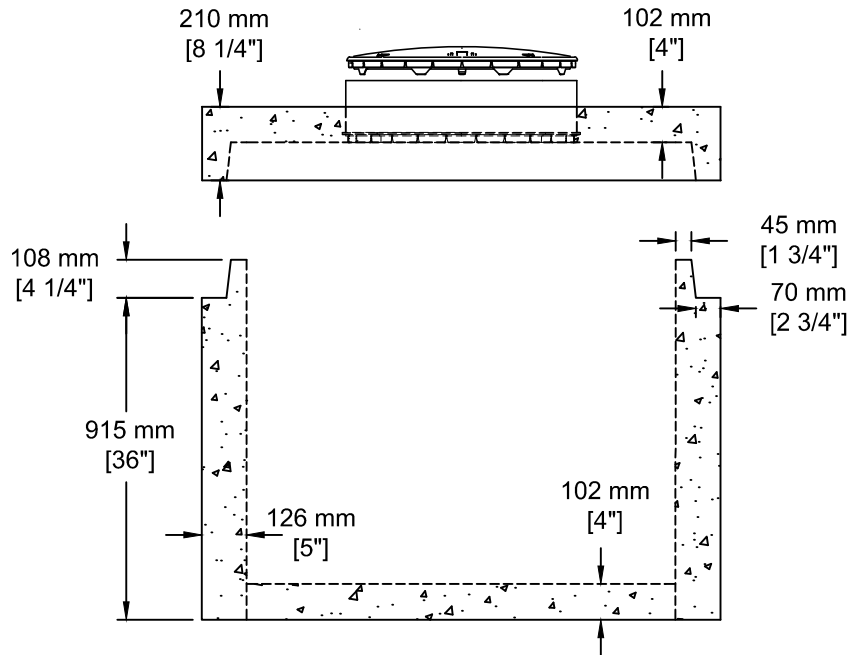

TEL: 250-495-7556
socp@socp.ca
www.socp.ca

Box 419, 11602 - 115 st Osoyoos, BC V0H 1V0

FAX: 250-495-3556

1200 ID (48") x 0.91vm
Pump Chamber

Product #

0153