

INSTALLATION INFORMATION

- 4 - 5T DOGBONE STYLE LIFTING ANCHORS (LID)
- 4 - 5T DOGBONE STYLE LIFTING ANCHORS (TANK)
- GASKET: CONSEAL BUTYL SEALANT

DESIGN SPECIFICATION
RESIDENTIAL LOADING

BURIAL DEPTH - **NO GREATER THAN 1M**
MANUFACTURED IN ACCORDANCE WITH: CSA A23.4, B-66
ASTM C1227

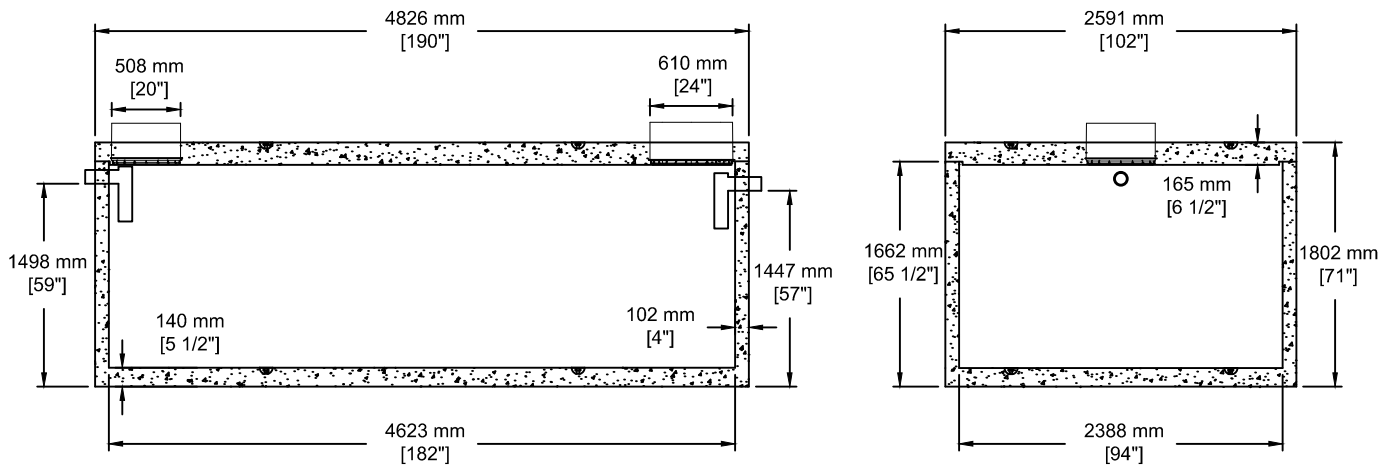

TEL: 250-495-7556
socp@socp.ca
www.socp.ca

Box 419, 11602 - 115 st Osoyoos, BC V0H 1V0

FAX: 250-495-3556

TS-1Ch 13638 litres (3000 Gal)
Septic Tank

Product #

0115-30