

INSTALLATION INFORMATION

- 20" DRAW DOWN - 100 GAL DOSE (454 L)
- 2 - 2.5T DOGBONE STYLE LIFTING ANCHORS (BARREL)
- 3 - 2.5T DOGBONE STYLE LIFTING ANCHORS (LID)
- WEIGHT: 3403 LBS / 1543 KG

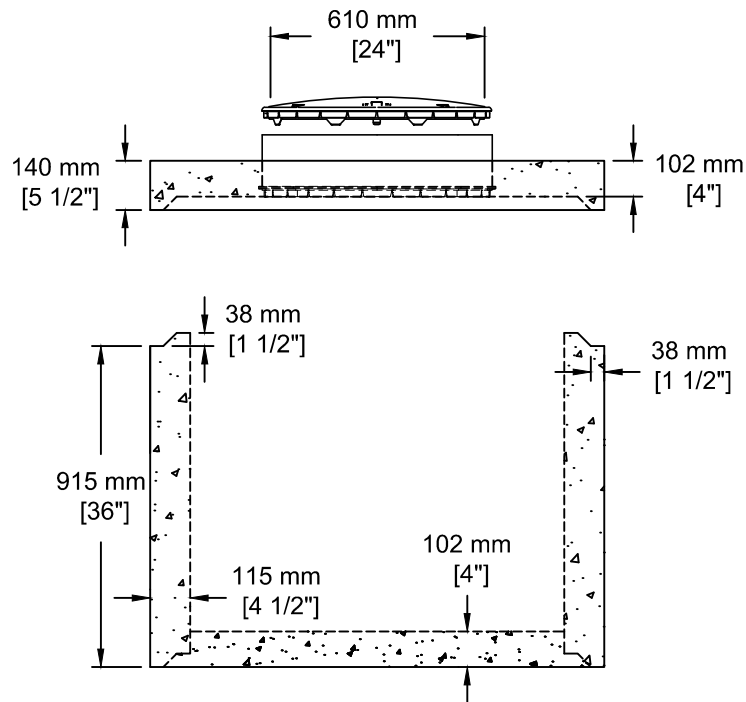

TEL: 250-495-7556
 socp@socp.ca
 www.socp.ca

Box 419, 11602 - 115 st Osoyoos, BC V0H 1V0

FAX: 250-495-3556

160 Gal Dosing Chamber (726 L)
 /c .91 vm Barrel / 100 mm IB / 100 mm Lid

Product #
0163-100