

INSTALLATION INFORMATION
 /C 1 - STEEL CABLE LOOP FOR LIFTING
 WEIGHT: 1256 LBS / 570 KG

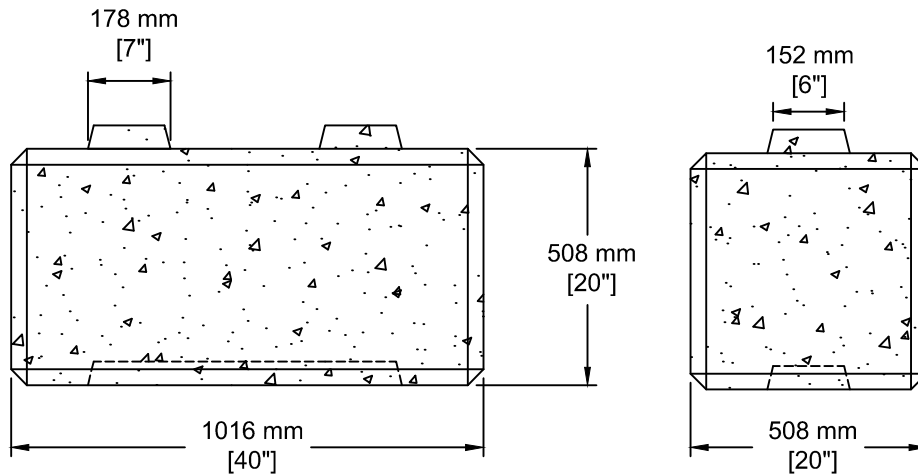

TEL: 250-495-7556
 socp@socp.ca
 www.socp.ca

Regular Precast
 Modular Block

Product #
0890