

INSTALLATION INFORMATION

2 - 2.5T DOGBONE STYLE LIFTING ANCHORS (BARREL)

2 - 2.5T DOGBONE STYLE LIFTING ANCHORS (LID)

WEIGHT: 1081 LBS / 2384 KG

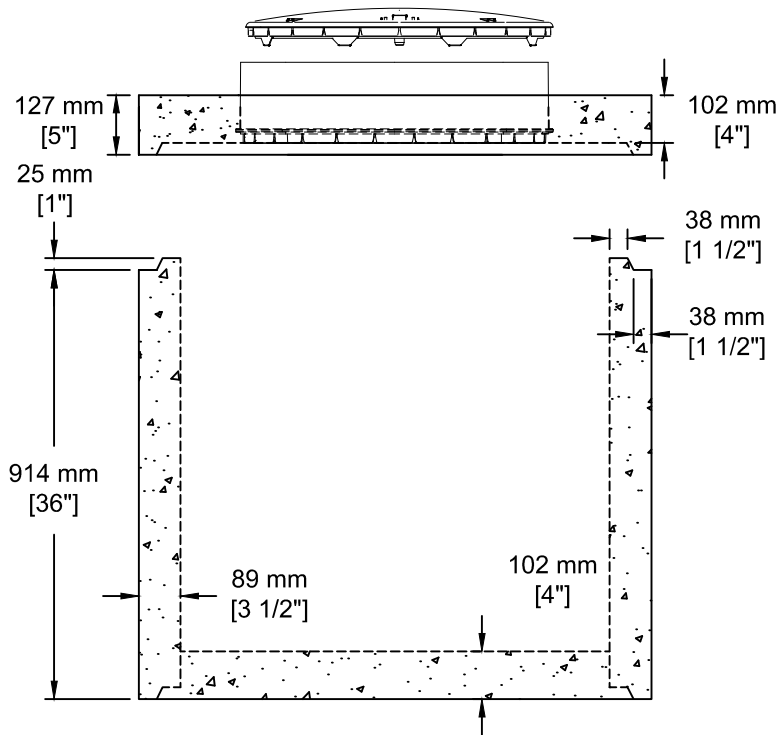

TEL: 250-495-7556
socp@socp.ca
www.socp.ca

Box 419, 11602 - 115 st Osoyoos, BC V0H 1V0

FAX: 250-495-3556

900 ID (36") x 0.91vm
Pump Chamber

Product #

0151