

INSTALLATION INFORMATION

SPREADER BAR & CABLES FOR HANDLING
 GASKET: 1" CONSEAL BUTYL SEALANT
 WEIGHT: 4580 LBS / 2077 KG (TOP)
 WEIGHT: 4440 LBS / 2014 KG (BOTTOM)

DESIGN SPECIFICATION

RESIDENTIAL LOADING
 BURIAL DEPTH - **NO GREATER THAN 1M**
 MANUFACTURED IN ACCORDANCE WITH: CSA A23.4, B-66
 ASTM C1227

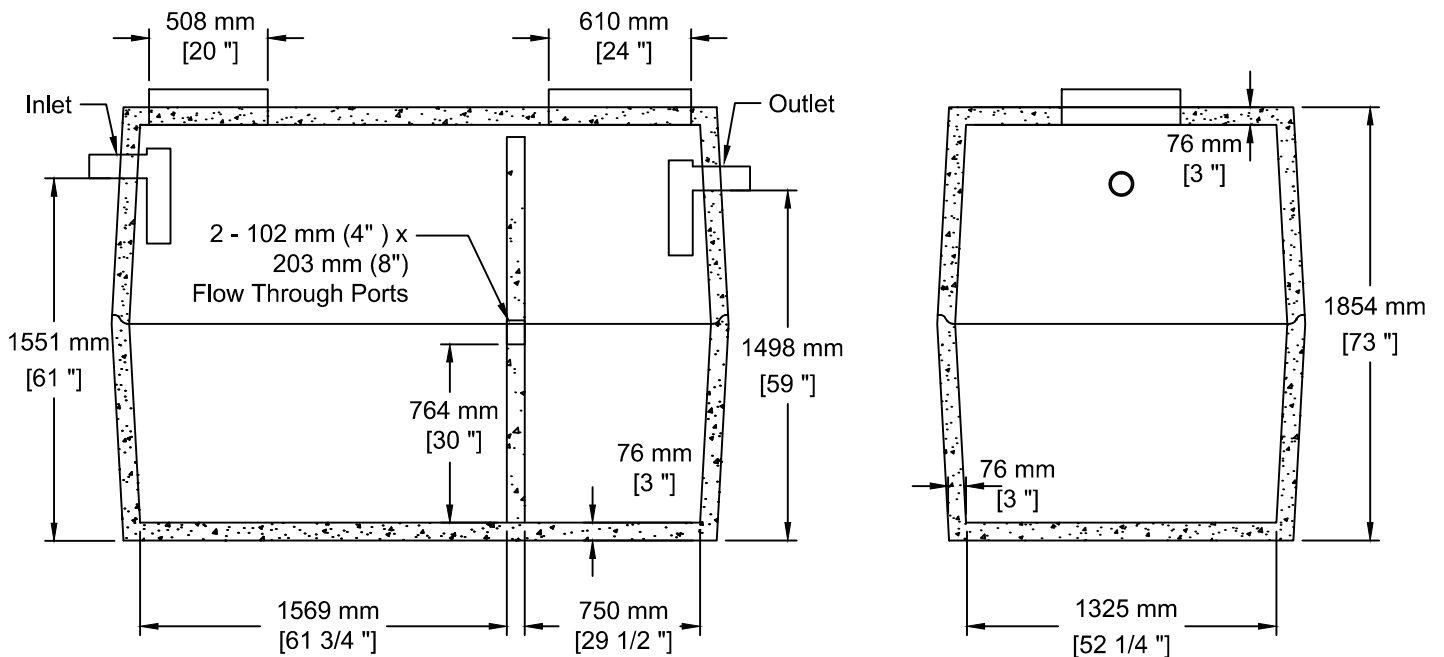

TEL: 250-495-7556
 socp@socp.ca
 www.socp.ca

MS-2Ch 4546 litres (1000 gal)
 Septic Tank

Product #

0117