

INSTALLATION INFORMATION

4 - 5T DOGBONE STYLE LIFTING ANCHORS (LID)
 4 - 5T DOGBONE STYLE LIFTING ANCHORS (TANK)
 GASKET: CONSEAL BUTYL SEALANT

DESIGN SPECIFICATION
RESIDENTIAL LOADING

BURIAL DEPTH - **NO GREATER THAN 1M**
 MANUFACTURED IN ACCORDANCE WITH: CSA A23.4, B-66
 ASTM C1227

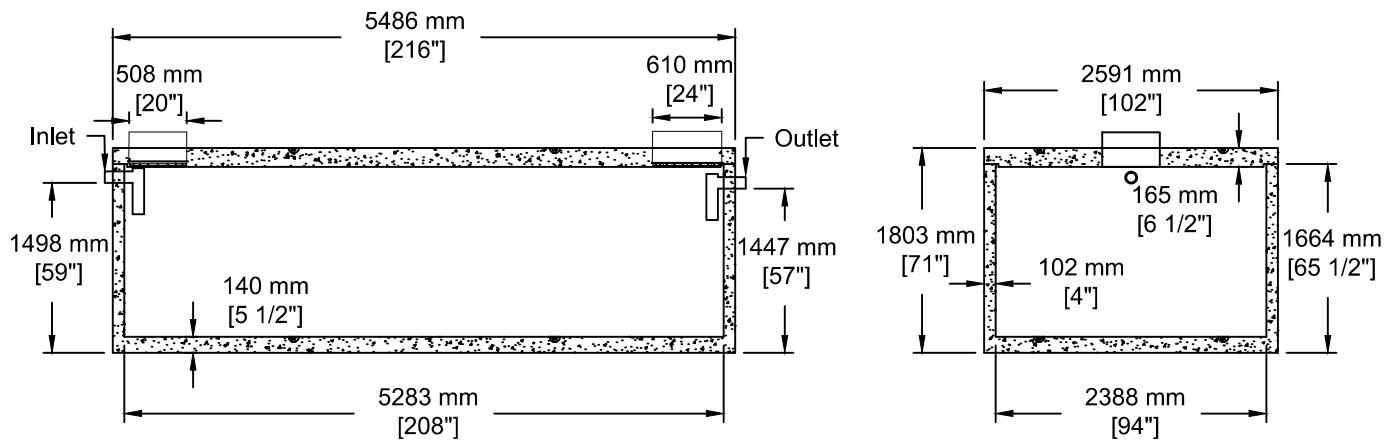

TEL: 250-495-7556
 socp@socp.ca
 www.socp.ca

SOUTH OKANAGAN
 CONCRETE PRODUCTS LTD

Box 419, 11602 - 115 st Osoyoos, BC V0H 1V0

FAX: 250-495-3556

TS-1Ch 15911 litres (3500 Gal)
 Septic Tank

Product #

0115-35